



Advance Xtanium linear LED drivers with SimpleSet technology are designed to give OEMs ultimate flexibility. The drivers' wide operating windows, slim profile and simple programming allow luminaire manufacturers to design luminaires of different sizes and lumen levels for office and retail applications.

### Specifications

Input Voltage (Vac)	Output Power (W)	Output Voltage (V)	Output Current (A)	Efficiency@ 35.7V and 70°C Case (%)	Max. Case Temp. (°C)	Input Current (A)	Max. Input Power (W)	THD @ Max. Load (%)	Power Factor @ Max. Load	Surge Protection (Ring Wave, KV)	Envir. Protection Rating
347	40	27 - 54	0.1 -1.1	87	85°C	0.14	49	<10%	>0.96	2.5	UL damp & dry

### Enclosure

	In. (mm)
Case Length	14.17 (360)
Case Width	1.18 (30)
Case Height	1.00 (25)
Mounting Length	13.78 (350)

### Wiring Diagram

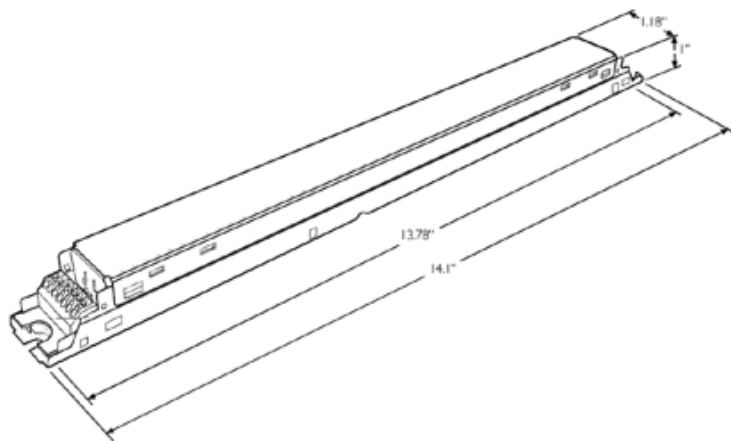
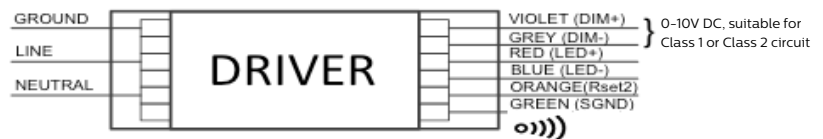

### Warning

Install in accordance with national and local electrical codes. Use 18AWG solid or tinned stranded copper wire.

### Grounding

Driver case must be grounded.

Dimming	Dimming Range (with specified dimmers)	Minimum Output Current (A)	Other Comments
0-10V Analog Class 1 or Class 2 Wiring	1% ~ 100% (for output current range 0.25-1.1A)	0.0025	Dimming source current: 150 µA

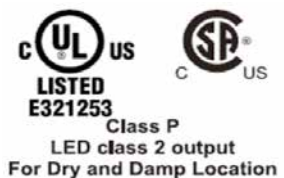

# Xitanium XG040C110V054BST1

40W 0.1–1.1A 54V 0–10V 1% 347V with SimpleSet

## Features

- 50,000+ hour lifetime<sup>1</sup>
- SimpleSet programmable
- Large operating window
- 1% minimum dim level

## Benefits

- Slim profile housing enables easy design-in with excellent thermal performance
- Enables simple, fast, flexible application-specific configurations
- Enables fixture designs with comprehensive application coverage for various loads and lumen levels

## Application

- Indoor linear applications such as troffers and pendants
- Office
- Education
- Healthcare
- Retail

## Electrical Specifications

All the specifications are typical and at 25°C Tcase unless specified otherwise.

## Product Data

Order Information	
Full Product Code	XG040C110V054BST1M (Mid-Pack, 18pcs/Box), 12NC: 929000775113
Line Frequency	50/60Hz
Min. Mains Voltage Operational	312 Vac
Max. Mains Voltage Operational	382 Vac
Output Information	
Maximum Open Circuit Voltage	< 60Vdc
Output Current Ripple (ripple = peak to average / average)	15% max. @ max Iout 4% max. @ Visible for stroboscopic frequency range 60Hz–3KHz
Output Current Tolerance (in the performance window)	<5%
Protections	Short Circuit, Open Circuit Protection for LED + and LED – and Temperature Foldback
Features	
0–10V Dimming	150µA source current from driver. See dim curve for detail.
AOC (adjustable output current)	100mA to 1100mA via external resistor or SimpleSet programming (default set to 1100mA, refer to graph)
Additional SimpleSet Configurable Features	Adjustable minimum dimming level, Dimming curve selection (linear or logarithmic), Adjustable output level, Adjustable output min., OEM write protection
Environment & Approbation	
Operating Ambient Temp. Range	–20°C to +50°C
Max. Case Temperature (Tcase)	85°C
Agency Approbations	UL8750, UL1310, CSA–C22.2 No. 250.13–12, CSA Class P, UL Class P
Electromagnetic Compliance	FCC Title 47 Part 15 Class A
Audible Noise	<24dB Class A
Weight	0.69Lbs / 0.32 kgs

1. Advance Xitanium LED drivers are manufactured to engineering standards correlating to a designed and average life expectancy of 50,000 hours of operation at maximum rated case temperature. Minimum 90% survivals based on MTBF modeling.

# Xitanium XG040C110V054BST1

40W 0.1-1.1A 54V 0-10V 1% 347V with SimpleSet

## Electrical Specifications

All the specifications are typical and at 25°C Tcase unless specified otherwise.

## 0-10V Dimming Curve

Dimming source current from the driver: 150µA (@ 0<Vdim<8V)

Minimum dim level: 1% of Iout (minimum 2.5mA)

Maximum output voltage on the dimming wires: 12V

## Approved Dimmer List

Manufacturer	Manufacturer Part Number
Lutron	Visit <a href="http://www.lutron.com/advance">www.lutron.com/advance</a> for a list of dimmers (Mark VII) that will work with this driver
Leviton	IllumaTech IP7 series
Advance	Sunrise - SR1200ZTUNV

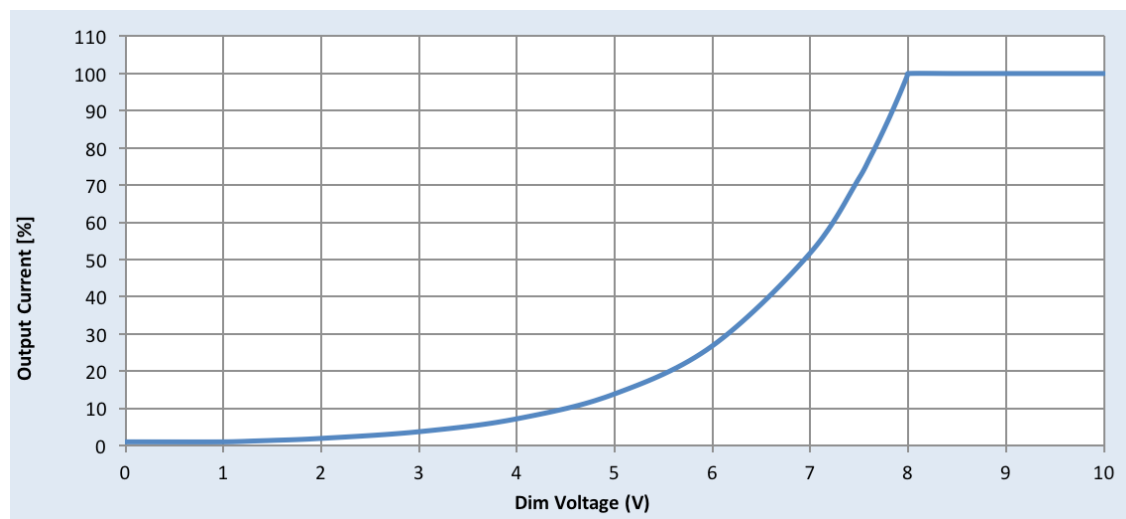
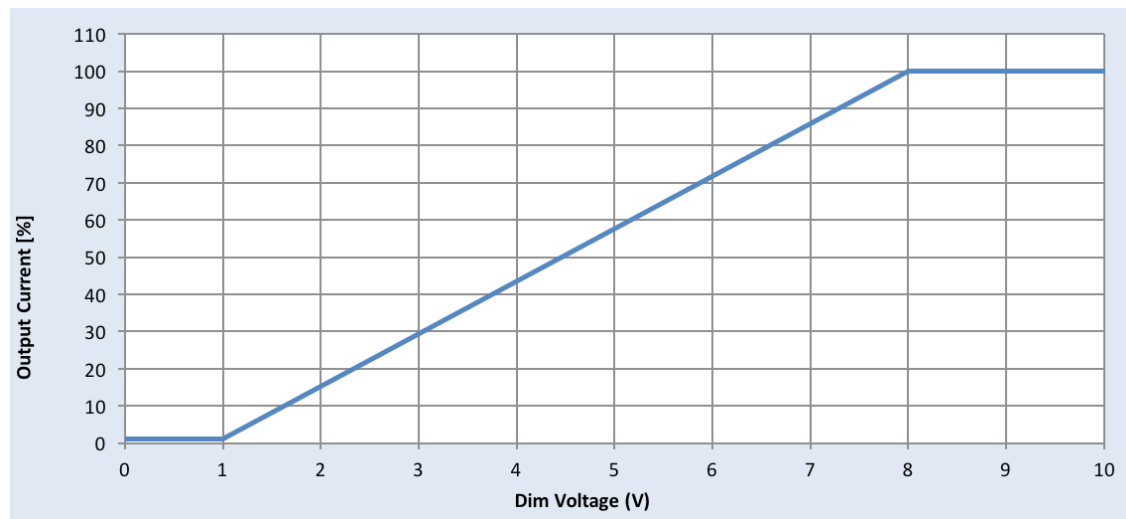

# Xitanium XG040C110V054BST1

40W 0.1-1.1A 54V 0-10V 1% 347V with SimpleSet

## Electrical Specifications

All the specifications are typical and at 25°C Tcase unless specified otherwise.

### AOC (Adjustable Output Current) Settings (Rset)

Rset (Ohms)	Current (mA)	Rset (Ohms)	Current (mA)
0	100	2000	733
100	100	2200	780
110	105	2400	823
120	111	2700	883
130	116	3000	941
150	125	3300	993
160	130	3600	1042
180	138	3900	1085
200	146	4000	1099
220	155	4700	1100
240	166	5100	1100
270	176	5600	1100
300	190	>100,000	1100
330	204		
360	215		
390	228		
430	245		
470	261		
510	277		
560	297		
620	318		
680	340		
750	368		
820	392		
910	422		
1000	452		
1100	485		
1200	515		
1300	545		
1500	602		
1600	632		
1800	684		

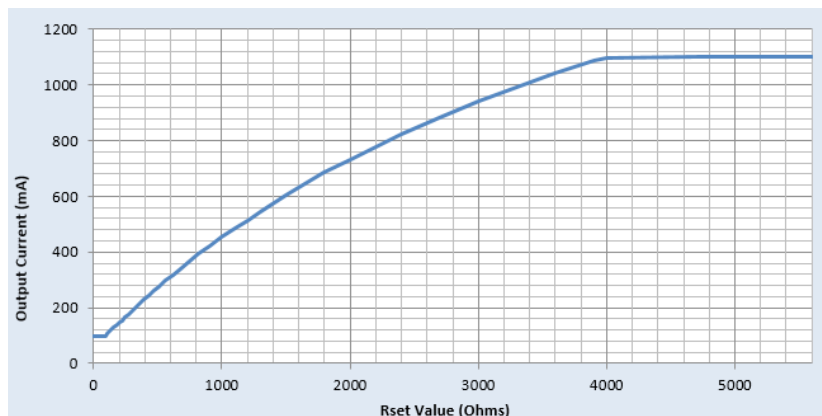

### Notes

1. Current is set via a resistor between Rset2 and SGND leads.
2. Any through-hole or SMD resistor with >0.25W and >20V can be used as Rset.
3. Driver will default to 1100mA when Rset is left open.

# Xitanium XG040C110V054BST1

40W 0.1-1.1A 54V 0-10V 1% 347V with SimpleSet

## Electrical Specifications

All the specifications are typical and at 25°C Tcase unless specified otherwise.

## Driver Output Window

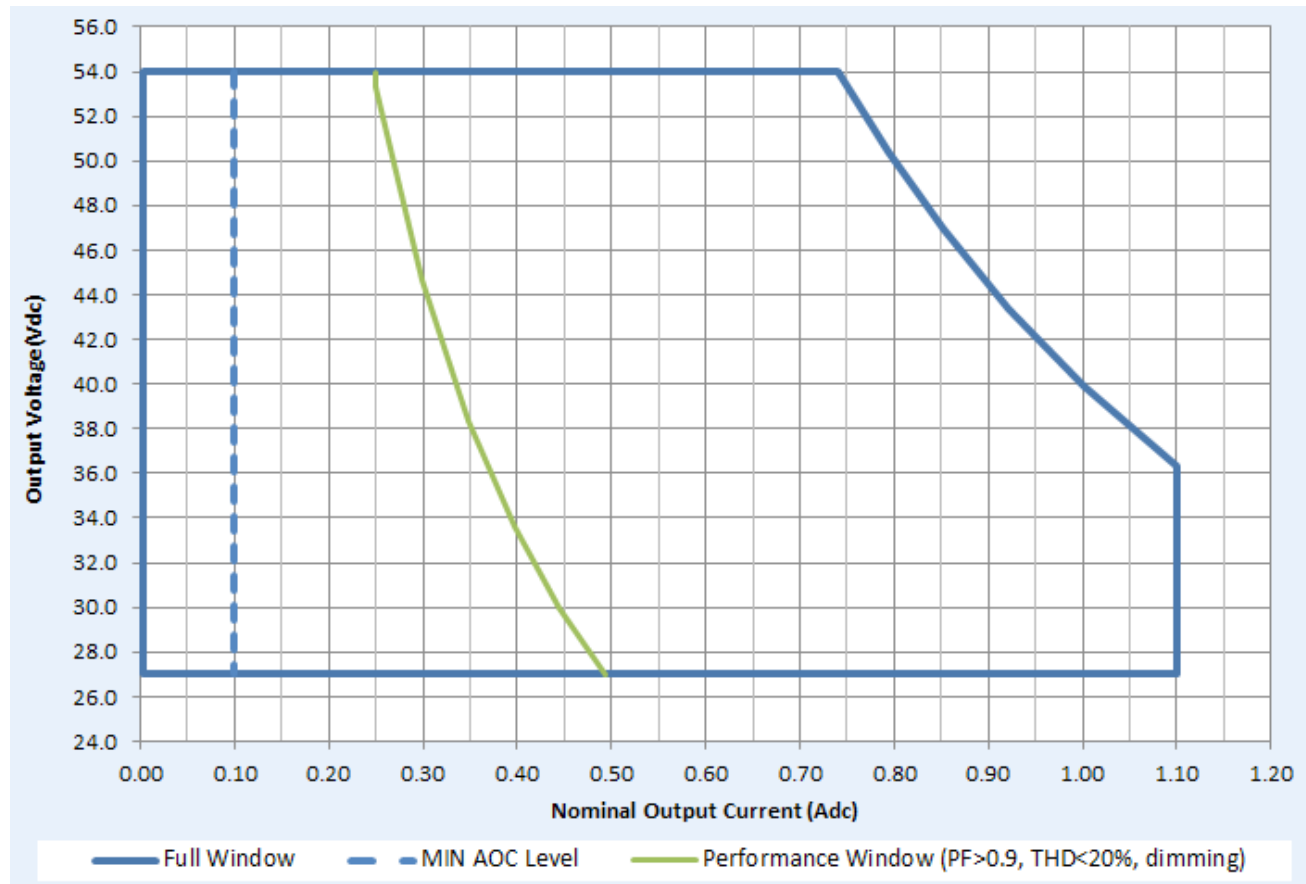

## Notes

1. Factory default output current is 1.1A.
2. For dimming to a minimum level of 1% the output current setting through AOC should be  $\geq 0.25A$ .

# Xitanium XG040C110V054BST1

40W 0.1-1.1A 54V 0-10V 1% 347V with SimpleSet

## Electrical Specifications

All the specifications are typical and at 25°C Tcase unless specified otherwise.

## Output Current Vs. Driver Case Temperature

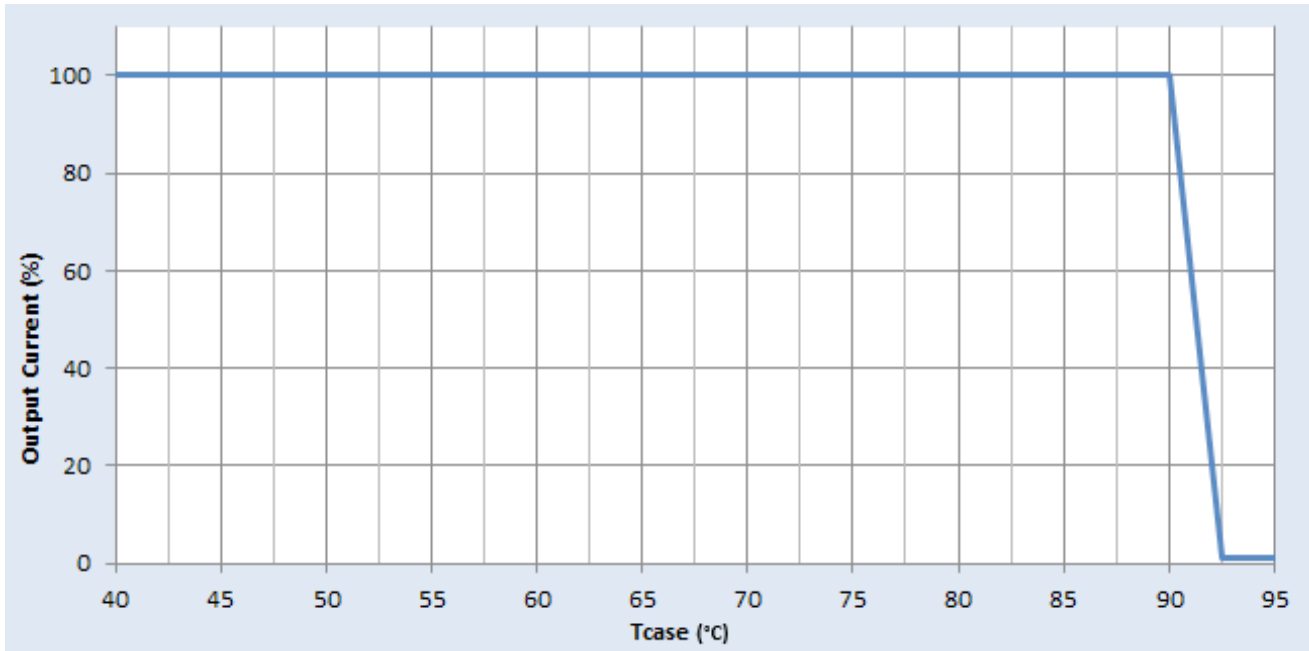

Note: There is  $\pm 5^\circ\text{C}$  tolerance on the driver case temperature.

## Driver Lifetime Vs. Driver Case Temperature

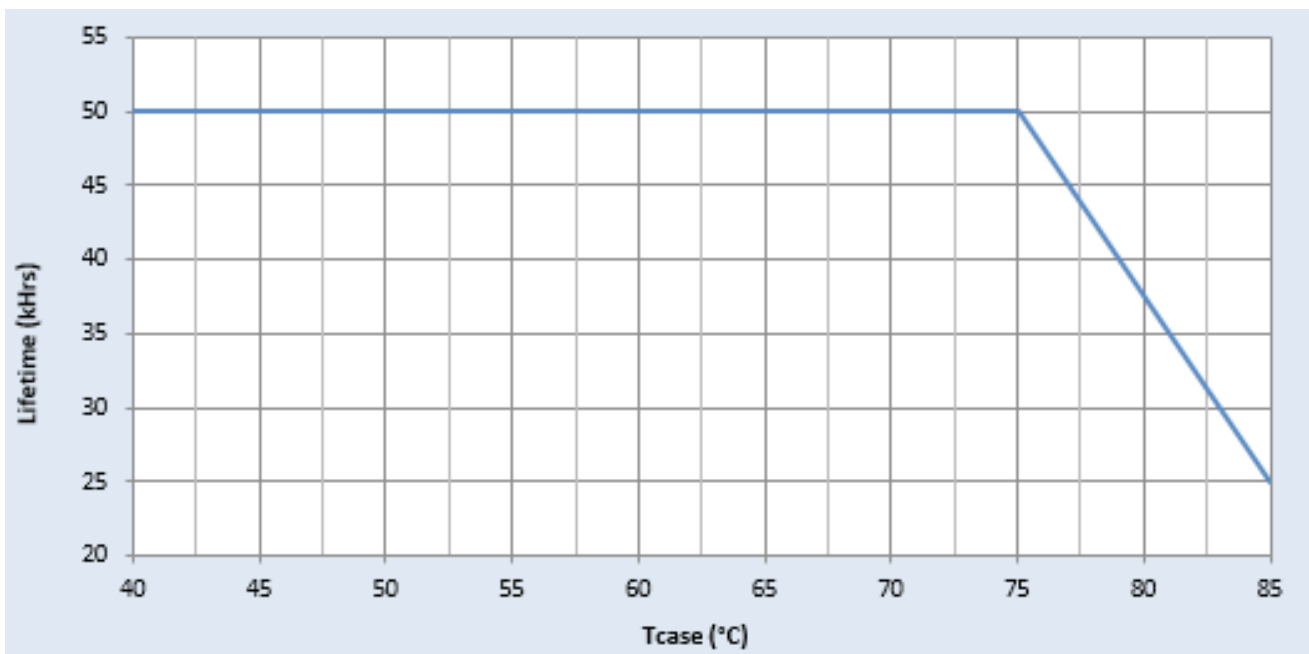

# Xitanium XG040C110V054BST1

40W 0.1-1.1A 54V 0-10V 1% 347V with SimpleSet

## Performance Characteristics

Based on measurements on a typical sample at 75°C T case. The accuracy of the measurements is within the tolerance of the measurement instruments.

## Efficiency Vs. Output Power

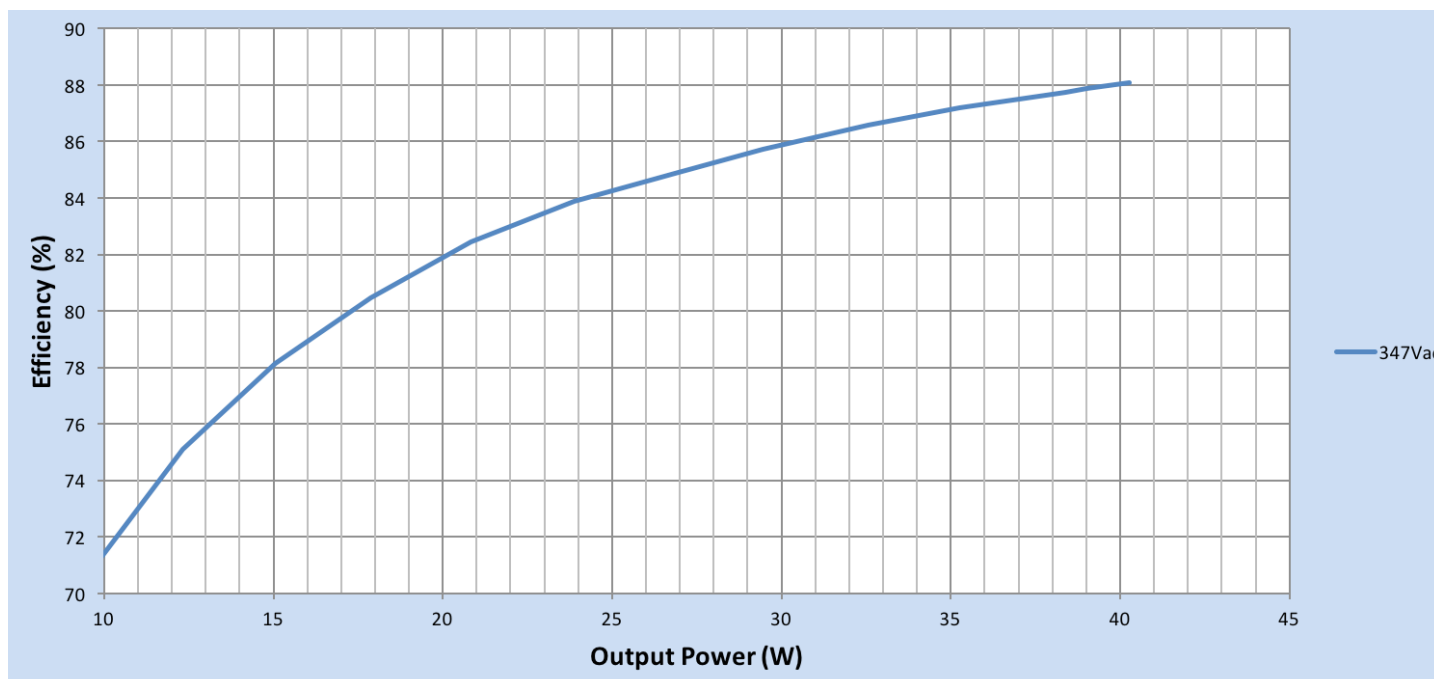

## Efficiency Vs. Output Voltage

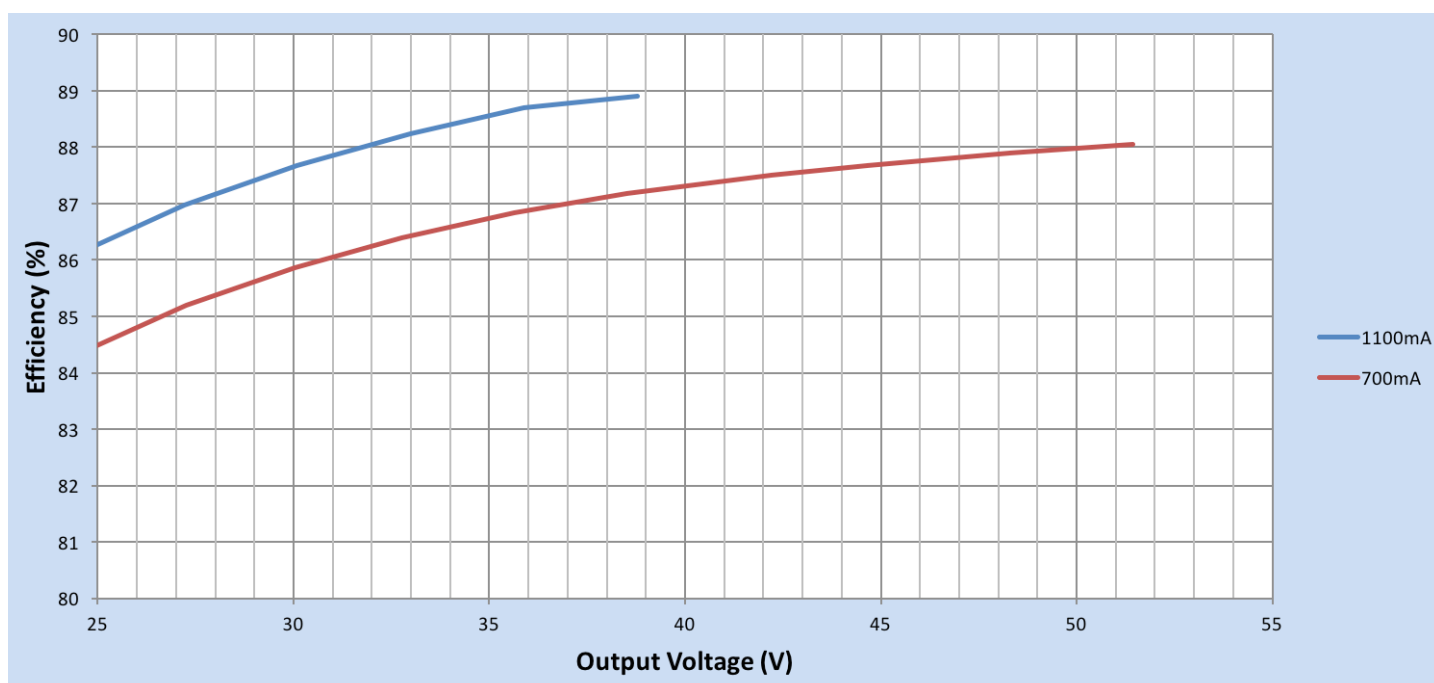

# Xitanium XG040C110V054BST1

40W 0.1-1.1A 54V 0-10V 1% 347V with SimpleSet

## Performance Characteristics

Based on measurements on a typical sample at 75°C T case. The accuracy of the measurements is within the tolerance of the measurement instruments.

### Power Factor Vs. Output Power

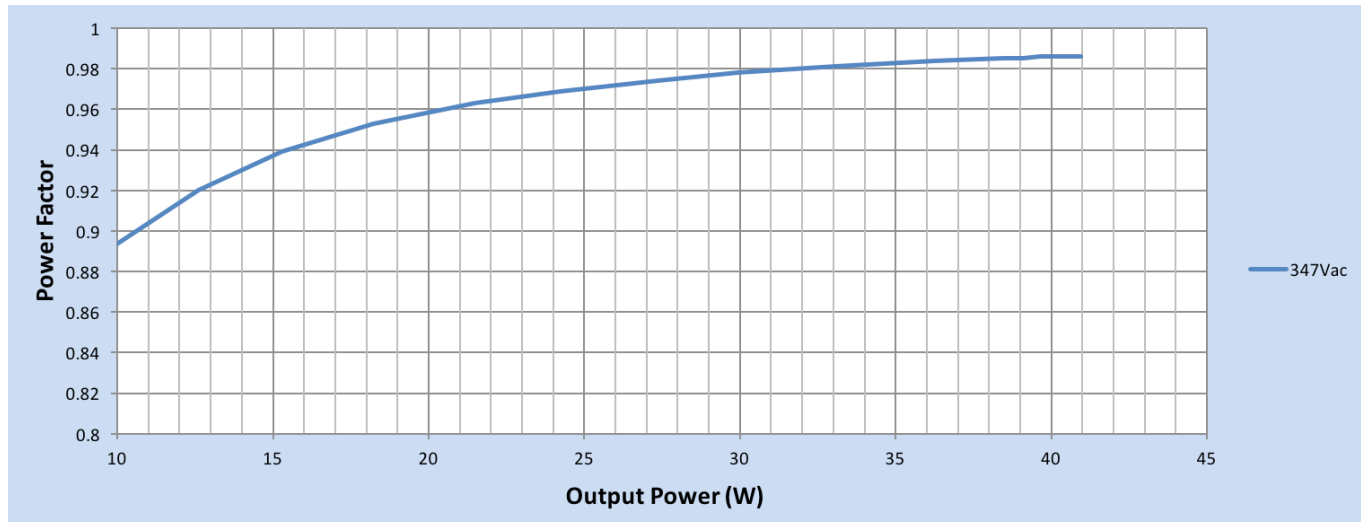

### Total Harmonic Distortion (THD) Vs. Output Power

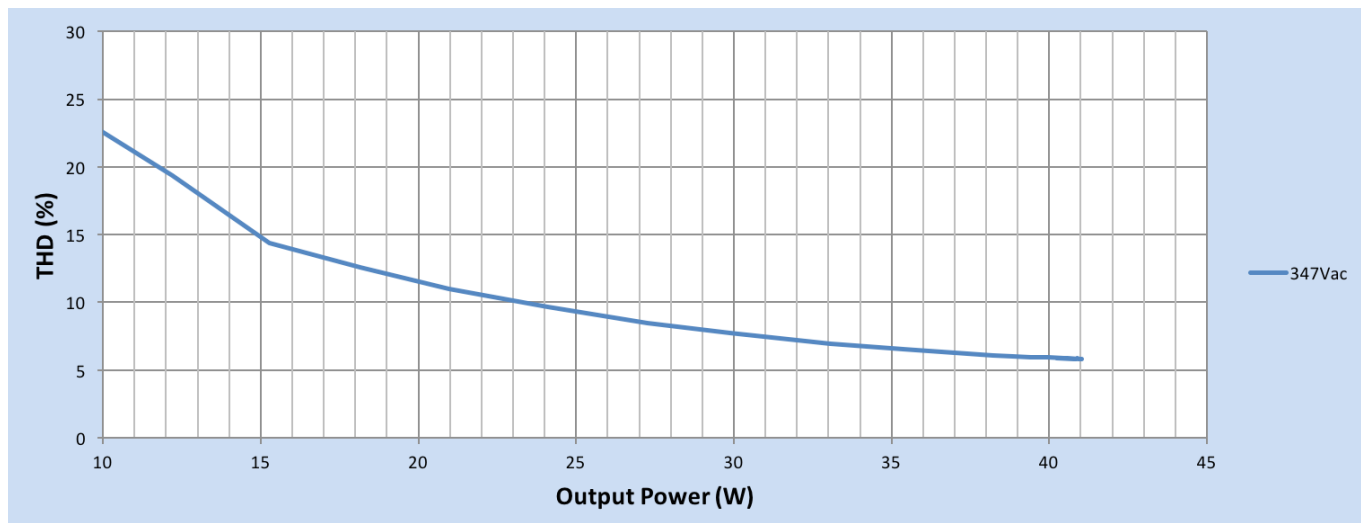



# Xitanium XG040C110V054BST1

40W 0.1-1.1A 54V 0-10V 1% 347V with SimpleSet

## Inrush Current Info

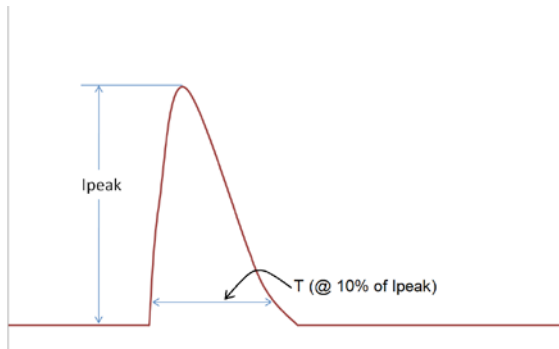

$V_{in}$	$I_{peak}$	$T (@ 10\% \text{ of } I_{peak})$
347 Vrms	30A	200 $\mu$ S

Inrush current is measured at peak of the corresponding line voltage. Source impedance per NEMA 410.

## Lightning Surge Info

ANSI Surge Type	Differential Mode (L-N)	Common Mode (L-G, N-G, L&N-G)
100kHz Ring Wave (w/t 30 $\Omega$ )	2.5KV	2.5KV

## Isolation

Isolation	Input	Output	0-10V	Enclosure
Input	–	2xU+1kV	2.5kV	2xU+1kV
Output	2xU+1kV	–	2.5kV	500V
0-10V (Class 2)	2.5kV	2.5kV	–	500V
Enclosure	2xU+1kV	500V	500V	–

U = Max. input voltage

The information presented in this document is not intended as any commercial offer and does not form part of any quotation or contract.

